

FCC Verification Test Report

Report No.: FV151013D05

Test Model: ECS-4000-PoE

Series Model: Vecow ECS-4000 Series, ECS-4000-PoER, ECS-4000-2G, ECS-4000-2R, ECS-4500, ECS-4600, ECS-XXXXXXXXXXXXXXXXX
("X" can be 0-9, A-Z or blank for marketing purpose)

Received Date: Oct. 13, 2015

Test Date: Oct. 14 ~ 16, 2015

Issued Date: Jan. 12, 2016

Applicant: Vecow Co., Ltd.

Address: 12F., No. 111, Zhongcheng Rd., Tucheng Dist., New Taipei City 23674
Taiwan (R. O. C.)

Issued By: Bureau Veritas Consumer Products Services (H.K.) Ltd., Taoyuan Branch

Lab Address: No. 47-2, 14th Ling, Chia Pau Vil., Lin Kou Dist., New Taipei City, Taiwan
(R.O.C.)



LAB CODE: 200836-0



This report is for your exclusive use. Any copying or replication of this report to or for any other person or entity, or use of our name or trademark, is permitted only with our prior written permission. This report sets forth our findings solely with respect to the test samples identified herein. The results set forth in this report are not indicative or representative of the quality or characteristics of the lot from which a test sample was taken or any similar or identical product unless specifically and expressly noted. Our report includes all of the tests requested by you and the results thereof based upon the information that you provided to us. You have 60 days from date of issuance of this report to notify us of any material error or omission caused by our negligence, provided, however, that such notice shall be in writing and shall specifically address the issue you wish to raise. A failure to raise such issue within the prescribed time shall constitute your unqualified acceptance of the completeness of this report, the tests conducted and the correctness of the report contents. Unless specific mention, the uncertainty of measurement has been explicitly taken into account to declare the compliance or non-compliance to the specification. The report must not be used by the client to claim product certification, approval, or endorsement by NVLAP, NIST, or any agency of the federal government. The report must not be used by the client to claim product certification, approval, or endorsement by TAF or any government agencies.

Table of Contents

Release Control Record	3
1 Certificate of Conformity	4
2 Summary of Test Results	5
2.1 Measurement Uncertainty.....	5
2.2 Modification Record.....	5
3 General Information	6
3.1 Features of EUT.....	6
3.2 General Description of EUT.....	6
3.3 Operating Modes of EUT and Determination of Worst Case Operating Mode.....	7
3.4 Test Program Used and Operation Descriptions	7
3.5 Primary Clock Frequencies of Internal Source	7
4 Configuration and Connections with EUT	8
4.1 Connection Diagram of EUT and Peripheral Devices	8
4.2 Configuration of Peripheral Devices and Cable Connections.....	9
5 Conducted Emissions at Mains Ports	10
5.1 Limits	10
5.2 Test Instruments.....	10
5.3 Test Arrangement.....	11
5.4 Test Results	12
6 Radiated Emissions up to 1 GHz	14
6.1 Limits	14
6.2 Test Instruments.....	15
6.3 Test Arrangement.....	16
6.4 Test Results	17
7 Radiated Emissions above 1 GHz	19
7.1 Limits	19
7.2 Test Instruments.....	20
7.3 Test Arrangement.....	21
7.4 Test Results	22
8 Pictures of Test Arrangements	24
8.1 Conducted Emissions at Mains Ports.....	24
8.2 Radiated Emissions up to 1 GHz.....	25
8.3 Radiated Emissions above 1 GHz	26
Appendix – Information on the Testing Laboratories	27



Release Control Record

Issue No.	Description	Date Issued
FV151013D05	Original release.	Jan. 12, 2016



1 Certificate of Conformity

Product: Ultra Compact Embedded System
Brand: Vecow
Test Model: ECS-4000-PoE
Series Model: Vecow ECS-4000 Series, ECS-4000-PoER, ECS-4000-2G, ECS-4000-2R, ECS-4500, ECS-4600, ECS-XXXXXXXXXXXXXXXXX
("X" can be 0-9, A-Z or blank for marketing purpose)
Sample Status: Engineering sample
Applicant: Vecow Co., Ltd.
Test Date: Oct. 14 ~ 16, 2015
Standards: 47 CFR FCC Part 15, Subpart B, Class A
ICES-003:2012 Issue 5, Class A
ANSI C63.4:2014

The above equipment has been tested by **Bureau Veritas Consumer Products Services (H.K.) Ltd., Taoyuan Branch**, and found compliance with the requirement of the above standards. The test record, data evaluation & Equipment Under Test (EUT) configurations represented herein are true and accurate accounts of the measurements of the sample's EMC characteristics under the conditions specified in this report.

Prepared by : Celia Chen , **Date:** Jan. 12, 2016
Celia Chen / Supervisor

Approved by : Henry Lai , **Date:** Jan. 12, 2016
Henry Lai / Director

2 Summary of Test Results

47 CFR FCC Part 15, Subpart B / ICES-003:2012 Issue 5, Class A

ANSI C63.4:2014

FCC Clause	ICES-003 Clause	Test Item	Result/Remarks	Verdict
15.107	6.1	AC Power Line Conducted Emissions	Minimum passing Class A margin is -10.75 dB at 0.22812 MHz	Pass
15.109	6.2.1	Radiated Emissions up to 1 GHz	Minimum passing Class A margin is -3.21 dB at 999.99 MHz	Pass
	6.2.2	Radiated Emissions above 1 GHz	Minimum passing Class A margin is -16.79 dB at 1538.75 MHz	Pass

Note: There is no deviation to the applied test methods and requirements covered by the scope of this report.

2.1 Measurement Uncertainty

Where relevant, the following measurement uncertainty levels have been estimated for tests performed on the EUT:

The listed uncertainties are the worst case uncertainty for the entire range of measurement. Please note that the uncertainty values are provided for informational purposes only and are not used in determining the PASS/FAIL results.

Measurement	Frequency	Expanded Uncertainty (k=2) (±)
Conducted Emissions at mains ports	150kHz ~ 30MHz	2.78 dB
Radiated Emissions up to 1 GHz	30MHz ~ 1GHz	4.34 dB
Radiated Emissions above 1 GHz	Above 1GHz	3.36 dB

2.2 Modification Record

There were no modifications required for compliance.

3 General Information

3.1 Features of EUT

The tests reported herein were performed according to the method specified by Vecow Co., Ltd., for detailed feature description, please refer to the manufacturer's specifications or user's manual.

3.2 General Description of EUT

Product	Ultra Compact Embedded System
Brand	Vecow
Test Model	ECS-4000-PoE
Series Model	Vecow ECS-4000 Series, ECS-4000-PoER, ECS-4000-2G, ECS-4000-2R, ECS-4500, ECS-4600, ECS-XXXXXXXXXXXXXX ("X" can be 0-9, A-Z or blank for marketing purpose)
Model Difference	For marketing purpose
Sample Status	Engineering sample
Operating Software	Window 8, Window 7, Linux
Power Supply Rating	6V to 36V DC in
Accessory Device	Adapter
Data Cable Supplied	N/A

Note:

1. The EUT is an Ultra Compact Embedded System with following interfaces:

- 2 COM*4 (RS-232/422/485)
- 2 USB 3.0*2
- 2 USB2.0*4 (External*3, Internal*1)
- 2 Isolated DIO*16 (DI*8, DO*8)
- 2 SIM card sockets*2
- 2 CFast card socket
- 2 DVI (resolution up to 1920 x 1080, 60Hz)
- 2 Display*2 (resolution up to 3840 x 2160, 60Hz)
- 2 PoE LAN (10/100Mbps)*4
- 2 LAN (10/100/1000Mbps)*2
- 2 Line out
- 2 Mic. in
- 2 DC input

2. The EUT was configured with the following key components:

Component	Brand	Model No. or P/N	Spec.
CPU	Intel	i7-5650U (Broadwell-U)	2.2GHz
Memory	Vecow	M340L-W28M1	4GB SOD PC3-10600 CL9
SSD	Memoright	MRSAJAA128GDB25I00	128GB 2.5"
CFast	Memoright	MCFA J500	32GB

3. The EUT uses following adapter.

Brand	Mean Well
Model	GS160A24
Input Power	100-240Vac, 50/60Hz, 2.0A
Output Power	24Vdc, 6.67A, 160W Max.
Power Line	Non-shielded DC (1.0m) with one ferrite core

3.3 Operating Modes of EUT and Determination of Worst Case Operating Mode

The EUT is designed with AC power of rating 100-240Vac, 50/60Hz.

For radiated emission evaluation, 230Vac/50Hz (for EN 55022 & AS/NZS CISPR 22), 120Vac/60Hz (for FCC Part 15) had been covered during the pre-test. The worst data was found at **230Vac/50Hz** and recorded in the applied test report. Then the other test items were tested at 120Vac/60Hz.

Test modes are presented in the report as below.

Mode	Test Condition
Conducted emission test	
1	Full system
Radiated emission test	
1	Full system

3.4 Test Program Used and Operation Descriptions

- a. Turned on the power of all equipment.
- b. EUT ran a test program to enable all functions.
- c. EUT read and wrote messages from/to HDD/SSD, CFast card and ext. HDDs.
- d. EUT sent and received messages to/from Notebook PCs (kept in a remote area) via two UTP LAN cables.
- e. EUT sent messages to ext. LCD Monitors. Then they displayed messages on their screen simultaneously.
- f. EUT sent messages to printer. Then it printed them out simultaneously.
- g. EUT sent messages to modems.
- h. EUT sent 1kHz audio signal to earphone.
- i. Cameras captured video image to LCD Monitors via EUT.
- j. Steps c-i were repeated.

3.5 Primary Clock Frequencies of Internal Source

The highest frequency generated or used within the EUT or on which the EUT operates or tunes is 2200 MHz, provided by Vecow Co., Ltd., for detailed internal source, please refer to the manufacturer's specifications.

4 Configuration and Connections with EUT

4.1 Connection Diagram of EUT and Peripheral Devices

TEST CONFIGURATION

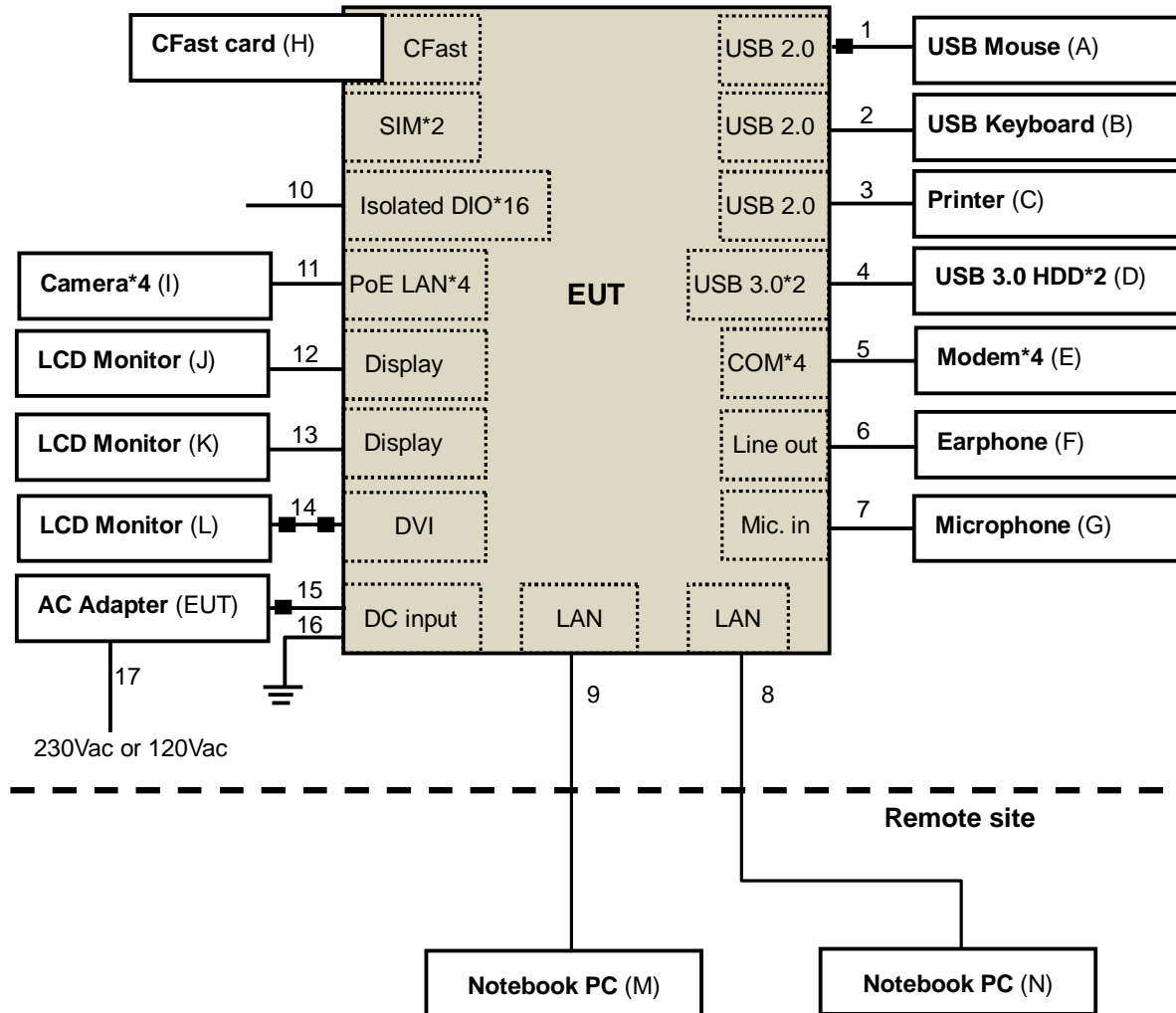

4.2 Configuration of Peripheral Devices and Cable Connections

ID	Product	Brand	Model No.	Serial No.	FCC ID	Remarks
A.	USB Mouse	Microsoft	1113	9170515896631	FCC DoC Approved	Provided by Lab
B.	USB KEYBOARD	BTC	5200U	G09302046630	FCC DoC Approved	Provided by Lab
C.	PRINTER	LEXMARK	Z33	N/A	FCC DoC Approved	Provided by Lab
D.	USB 3.0 Hard Disk*2	WD	WDBUZG0010BB K-PESN	WXN1E84F21W	FCC DoC Approved	Provided by Lab
		WD	WDBUZG0010BB K-PESN	WXN1E94A9S8X	FCC DoC Approved	Provided by Lab
E.	MODEM*4	ACEEX	1414	980020534	IFAXDM1414	Provided by Lab
		ACEEX	1414	980020532	IFAXDM1414	Provided by Lab
		ACEEX	1414	980020538	IFAXDM1414	Provided by Lab
		ACEEX	1414	0206026752	IFAXDM1414	Provided by Lab
F.	EARPHONE	PHILIPS	SBC HL145	N/A	N/A	Provided by Lab
G.	MICROPHONE	Labtec	mic-333	N/A	N/A	Provided by Lab
H.	CFast card	Memoright	MCFA J500	T032C21C390008	N/A	Supplied by client
I.	Camera*4	3M	A301MIF-3N	T31504053/54/55/56	N/A	Supplied by client
J.	LCD Monitor	ViewSonic	HTEMCP68FLVW DN	2828713E09080009	FCC DoC Approved	Provided by Lab
K.	LCD Monitor	ASUS	HTDMCP28JVUS DN	2651804E03070001	FCC DoC Approved	Provided by Lab
L.	LCD Monitor	DELL	U2410	CN082WXD728720CC 10NL	FCC DoC Approved	Provided by Lab
M.	Notebook PC	SONY	SVS151A12P	275548477001024	FCC DoC Approved	Provided by Lab
N.	Notebook PC	DELL	PP27L	8SNZ12S	FCC DoC Approved	Provided by Lab

Note:

1. All power cords of the above support units are non-shielded (1.8m).
2. Items M-N acted as communication partners to transfer data.

ID	Descriptions	Qty.	Length (m)	Shielding (Yes/No)	Cores (Qty.)	Remarks
1.	USB cable	1	1.85	Y	1	Provided by Lab
2.	USB cable	1	1.55	Y	0	Provided by Lab
3.	USB cable	1	1.8	Y	0	Provided by Lab
4.	USB cable	2	0.5	Y	0	Provided by Lab
5.	RS232 cable	4	1.0	Y	0	Provided by Lab
6.	Audio cable	1	1.2	N	0	Provided by Lab
7.	Audio cable	1	2.4	N	0	Provided by Lab
8.	LAN cable	1	10.0	N	0	Provided by Lab
9.	LAN cable	1	10.0	N	0	Provided by Lab
10.	Data cable	16	0.65	N	0	Supplied by client
11.	LAN cable	4	3.0	Y	0	Provided by Lab
12.	Display cable	1	1.8	Y	0	Provided by Lab
13.	Display cable	1	1.8	Y	0	Provided by Lab
14.	DVI cable	1	1.8	Y	2	Provided by Lab
15.	DC power cable	1	1.0	N	1	Supplied by client
16.	Ground cable	1	1.4	N	0	Provided by Lab
17.	AC power cord	1	1.8	N	0	Provided by Lab

Note: The core(s) is(are) originally attached to the cable(s).

5 Conducted Emissions at Mains Ports

5.1 Limits

Frequency (MHz)	Class A (dBuV)		Class B (dBuV)	
	Quasi-peak	Average	Quasi-peak	Average
0.15 - 0.5	79	66	66 - 56	56 - 46
0.50 - 5.0	73	60	56	46
5.0 - 30.0	73	60	60	50

Notes: 1. The lower limit shall apply at the transition frequencies.
2. The limit decreases linearly with the logarithm of the frequency in the range of 0.15 to 0.50 MHz.

5.2 Test Instruments

Description & Manufacturer	Model No.	Serial No.	Cal. Date	Cal. Due
ROHDE & SCHWARZ TEST RECEIVER	ESCS 30	100276	Apr. 01, 2015	Mar. 31, 2016
ROHDE & SCHWARZ Artificial Mains Network (for EUT)	ENV216	101197	Apr. 27, 2015	Apr. 26, 2016
LISN With Adapter (for EUT)	AD10	C10Ada-002	Apr. 27, 2015	Apr. 26, 2016
ROHDE & SCHWARZ Artificial Mains Network (for peripherals)	ESH3-Z5	100218	Nov. 25, 2014	Nov. 24, 2015
SCHWARZBECK Artificial Mains Network (For EUT)	NNLK8129	8129229	May 06, 2015	May 05, 2016
Software	Cond_V7.3.7	NA	NA	NA
RF cable (JYEBAO) With 10dB PAD	5D-FB	Cable-C10.01	Feb. 17, 2015	Feb. 16, 2016
SUHNER Terminator (For ROHDE & SCHWARZ LISN)	65BNC-5001	E1-011484	May 19, 2015	May 18, 2016
ROHDE & SCHWARZ Artificial Mains Network (For TV EUT)	ESH3-Z5	100220	Nov. 20, 2014	Nov. 19, 2015
LISN With Adapter (for TV EUT)	100220	N/A	Nov. 20, 2014	Nov. 19, 2015

Notes: 1. The calibration interval of the above test instruments is 12 months and the calibrations are traceable to NML/ROC and NIST/USA.
2. The test was performed in Shielded Room No. 10.
3. The VCCI Site Registration No. C-1852.
4. Tested Date: Oct. 14, 2015.

5.3 Test Arrangement

- The EUT was placed 0.4 meters from the conducting wall of the shielded room with EUT being connected to the power mains through a line impedance stabilization network (LISN). Other support units were connected to the power mains through another LISN. The two LISNs provide 50 Ohm/ 50uH of coupling impedance for the measuring instrument.
- Both lines of the power mains connected to the EUT were checked for maximum conducted interference.
- The test results of conducted emissions at mains ports are recorded of six worst margins for quasi-peak (mandatory) [and average (if necessary)] values against the limits at frequencies of interest unless the margin is 20 dB or greater.

Note: The resolution bandwidth and video bandwidth of test receiver is 9kHz for quasi-peak detection (QP) and average detection (AV) at frequency 0.15MHz-30MHz.

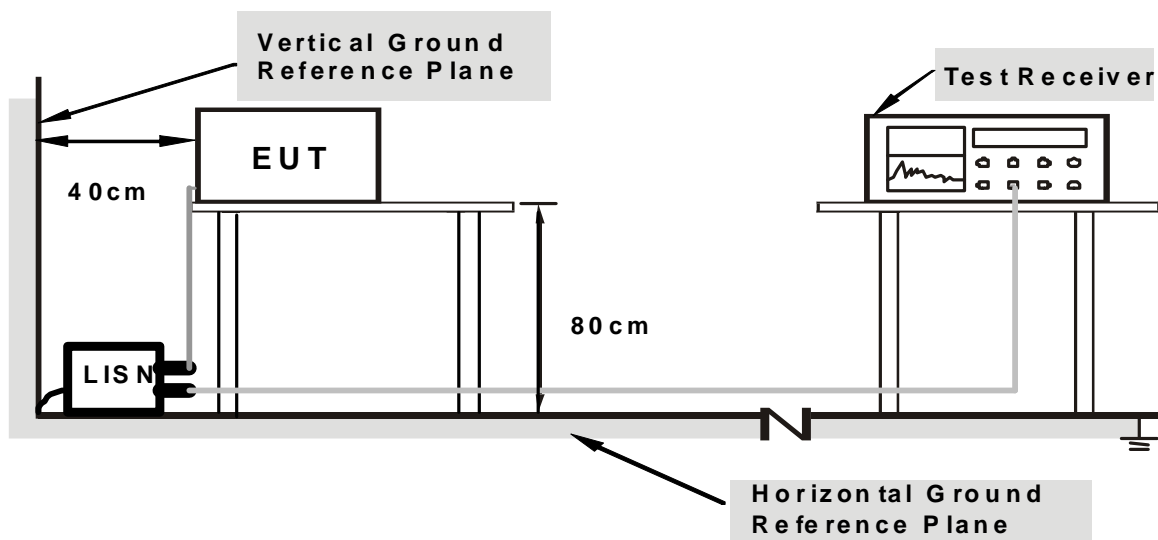

Note: Support units were connected to second LISN.

For the actual test configuration, please refer to the related item – Photographs of the Test Configuration.

5.4 Test Results

Frequency Range	150kHz ~ 30MHz	Detector Function & Resolution Bandwidth	Quasi-Peak (QP) / Average (AV), 9kHz
Input Power	120Vac, 60Hz	Environmental Conditions	23°C, 74%RH
Tested by	Chin-Wen Wang		
Test Mode	Mode 1		

Phase Of Power : Line (L)										
No	Frequency (MHz)	Correction Factor (dB)	Reading Value (dBuV)		Emission Level (dBuV)		Limit (dBuV)		Margin (dB)	
			Q.P.	AV.	Q.P.	AV.	Q.P.	AV.	Q.P.	AV.
1	0.16172	9.67	40.96	32.31	50.63	41.98	79.00	66.00	-28.37	-24.02
2	0.22812	9.67	45.60	45.31	55.27	54.98	79.00	66.00	-23.73	-11.02
3	0.34794	9.67	39.53	39.20	49.20	48.87	79.00	66.00	-29.80	-17.13
4	0.68125	9.68	32.12	29.38	41.80	39.06	73.00	60.00	-31.20	-20.94
5	0.90781	9.70	27.31	26.36	37.01	36.06	73.00	60.00	-35.99	-23.94
6	24.04297	9.95	26.60	26.07	36.55	36.02	73.00	60.00	-36.45	-23.98

Remarks:

1. Q.P. and AV. are abbreviations of quasi-peak and average individually.
2. The emission levels of other frequencies were very low against the limit.
3. Margin value = Emission level – Limit value
4. Correction factor = Insertion loss + Cable loss
5. Emission Level = Correction Factor + Reading Value

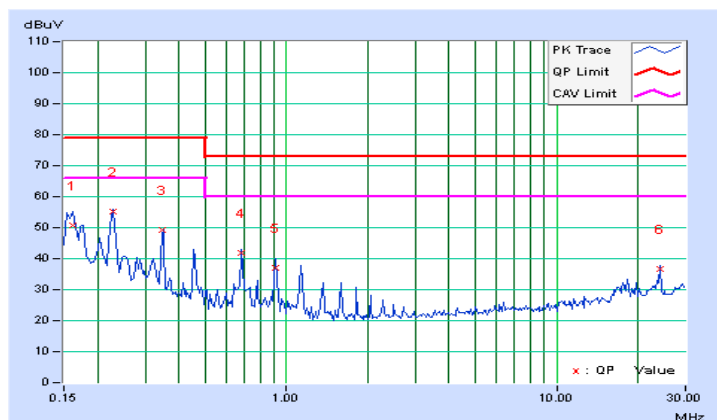

Frequency Range	150kHz ~ 30MHz	Detector Function & Resolution Bandwidth	Quasi-Peak (QP) / Average (AV), 9kHz
Input Power	120Vac, 60Hz	Environmental Conditions	23°C, 74%RH
Tested by	Chin-Wen Wang		
Test Mode	Mode 1		

Phase Of Power : Neutral (N)										
No	Frequency (MHz)	Correction Factor (dB)	Reading Value (dBuV)		Emission Level (dBuV)		Limit (dBuV)		Margin (dB)	
			Q.P.	AV.	Q.P.	AV.	Q.P.	AV.	Q.P.	AV.
1	0.16562	9.70	42.88	39.08	52.58	48.78	79.00	66.00	-26.42	-17.22
2	0.22812	9.71	45.66	45.54	55.37	55.25	79.00	66.00	-23.63	-10.75
3	0.34922	9.71	39.77	39.20	49.48	48.91	79.00	66.00	-29.52	-17.09
4	0.68510	9.72	31.69	30.41	41.41	40.13	73.00	60.00	-31.59	-19.87
5	0.91427	9.73	29.16	28.53	38.89	38.26	73.00	60.00	-34.11	-21.74
6	24.04298	10.01	28.49	27.98	38.50	37.99	73.00	60.00	-34.50	-22.01

Remarks:

1. Q.P. and AV. are abbreviations of quasi-peak and average individually.
2. The emission levels of other frequencies were very low against the limit.
3. Margin value = Emission level – Limit value
4. Correction factor = Insertion loss + Cable loss
5. Emission Level = Correction Factor + Reading Value

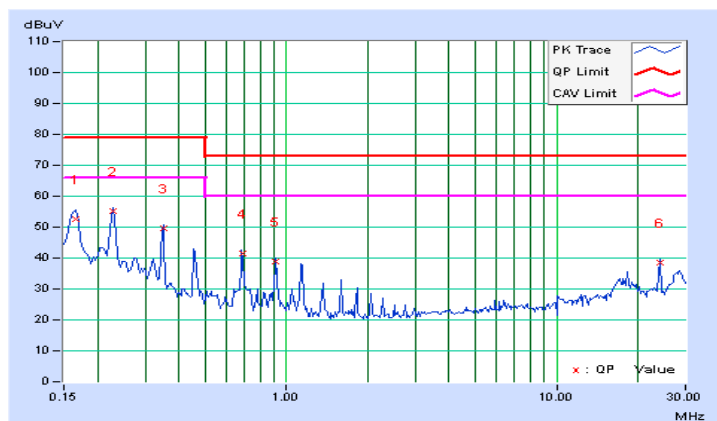

6 Radiated Emissions up to 1 GHz

6.1 Limits

Emissions radiated outside of the specified bands, shall be according to the general radiated limits as following:

Radiated Emissions Limits at 10 meters (dB μ V/m)				
Frequencies (MHz)	FCC 15B / ICES-003, Class A	FCC 15B / ICES-003, Class B	CISPR 22, Class A	CISPR 22, Class B
30-88	39	29.5	40	30
88-216	43.5	33.1		
216-230	46.4	35.6		
230-960			47	37
960-1000	49.5	43.5		

Radiated Emissions Limits at 3 meters (dB μ V/m)				
Frequencies (MHz)	FCC 15B / ICES-003, Class A	FCC 15B / ICES-003, Class B	CISPR 22, Class A	CISPR 22, Class B
30-88	49.5	40	50.5	40.5
88-216	54	43.5		
216-230	56.9	46		
230-960			57.5	47.5
960-1000	60	54		

- Notes:
1. The lower limit shall apply at the transition frequencies.
 2. Emission level (dB μ V/m) = 20 log Emission level (uV/m).
 3. QP detector shall be applied if not specified.

6.2 Test Instruments

Description & Manufacturer	Model No.	Serial No.	Cal. Date	Cal. Due
ROHDE & SCHWARZ TEST RECEIVER	ESCI	100412	Aug. 24, 2015	Aug. 23, 2016
Schwarzbeck BILOG Antenna	VULB9168	9168-479	Feb. 02, 2015	Feb. 01, 2016
CT Turn Table	TT100	CT-0055	NA	NA
CT Tower	AT100	CT-0055	NA	NA
Software	Radiated_V7.6.15.9.4	NA	NA	NA
ADT RF Switches BOX	EM-H-01-1	1002	Jun. 17 2015	Jun. 16, 2016
WOKEN RF cable	8D	CABLE-ST6-01	Jun. 17 2015	Jun. 16, 2016

Notes: 1. The calibration interval of the above test instruments is 12 months and the calibrations are traceable to NML/ROC and NIST/USA.

2. The test was performed in Open Site No. 6.
3. The VCCI Site Registration No. R-728.
4. The FCC Site Registration No. 90427.
5. Tested Date: Oct. 15, 2015.

6.3 Test Arrangement

- The EUT was placed on the top of a rotating table 0.8 meters above the ground at an accredited test facility. The table was rotated 360 degrees to determine the position of the highest radiation.
- The EUT was set 10 meters away from the interference-receiving antenna, which was mounted on the top of a variable-height antenna tower.
- The antenna is a broadband antenna, and its height is varied from one meter to four meters above the ground to determine the maximum value of the field strength. Both horizontal and vertical polarizations of the antenna are set to make the measurement.
- For each suspected emission, the EUT was arranged to its worst case and then the antenna was tuned to heights from 1 meter to 4 meters and the rotatable table was turned from 0 degrees to 360 degrees to find the maximum reading.
- The test-receiver system was set to quasi-peak detect function and specified bandwidth with maximum hold mode when the test frequency is up to 1 GHz.

Note: The resolution bandwidth and video bandwidth of test receiver/spectrum analyzer is 120kHz for quasi-peak detection (QP) at frequency up to 1GHz.

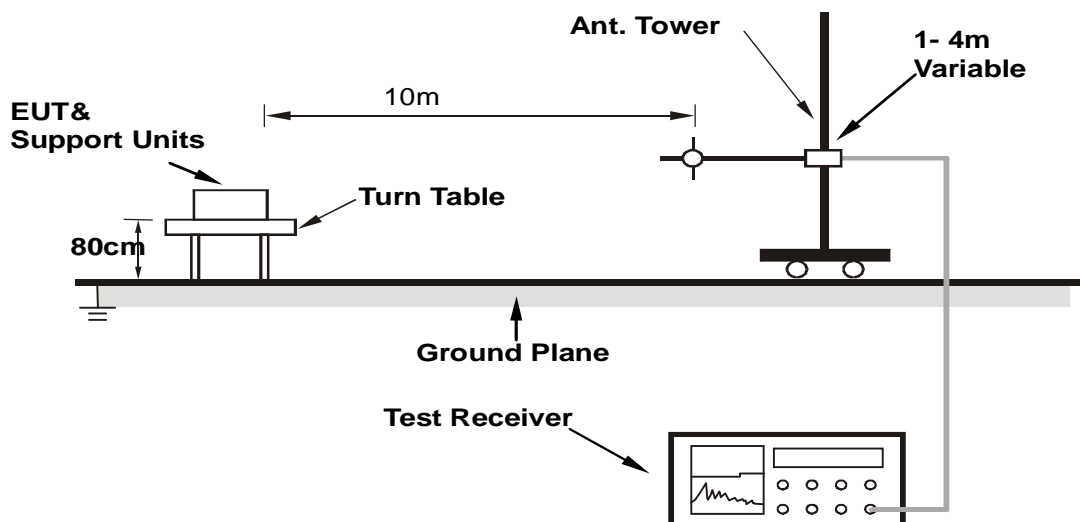

For the actual test configuration, please refer to the related item – Photographs of the Test Configuration.

6.4 Test Results

Frequency Range	30MHz ~ 1GHz	Detector Function & Resolution Bandwidth	Quasi-Peak (QP), 120kHz
Tested by	Vhenson Huang	Environmental Conditions	25°C, 63%RH
Test Mode	Mode 1		

Antenna Polarity & Test Distance : Horizontal at 10 m								
No	Frequency (MHz)	Emission Level (dBuV/m)	Limit (dBuV/m)	Margin (dB)	Antenna Height (m)	Table Angle (Degree)	Raw Value (dBuV)	Correction Factor (dB/m)
1	54.82	24.53 QP	40.00	-15.47	4.00 H	200	9.93	14.60
2	125.01	29.46 QP	40.00	-10.54	4.00 H	185	16.14	13.32
3	213.84	29.14 QP	40.00	-10.86	4.00 H	264	16.75	12.39
4	250.03	33.46 QP	47.00	-13.54	2.91 H	120	18.82	14.64
5	308.57	37.15 QP	47.00	-9.85	2.52 H	206	19.93	17.22
6	468.77	40.95 QP	47.00	-6.05	1.92 H	170	19.30	21.65
7	617.18	40.61 QP	47.00	-6.39	1.96 H	84	15.45	25.16
8	702.88	38.25 QP	47.00	-8.75	1.00 H	161	12.24	26.01
9	745.12	38.90 QP	47.00	-8.10	1.17 H	131	11.61	27.29
10	890.62	40.02 QP	47.00	-6.98	1.00 H	198	10.82	29.20
11	999.99	43.79 QP	47.00	-3.21	1.00 H	104	13.12	30.67

Remarks:

1. Emission Level(dBuV/m) = Raw Value(dBuV) + Correction Factor(dB/m)
2. Correction Factor(dB/m) = Antenna Factor (dB/m) + Cable Factor (dB) – Pre-Amplifier Factor (dB)
3. The other emission levels were very low against the limit.
4. Margin value = Emission level – Limit value

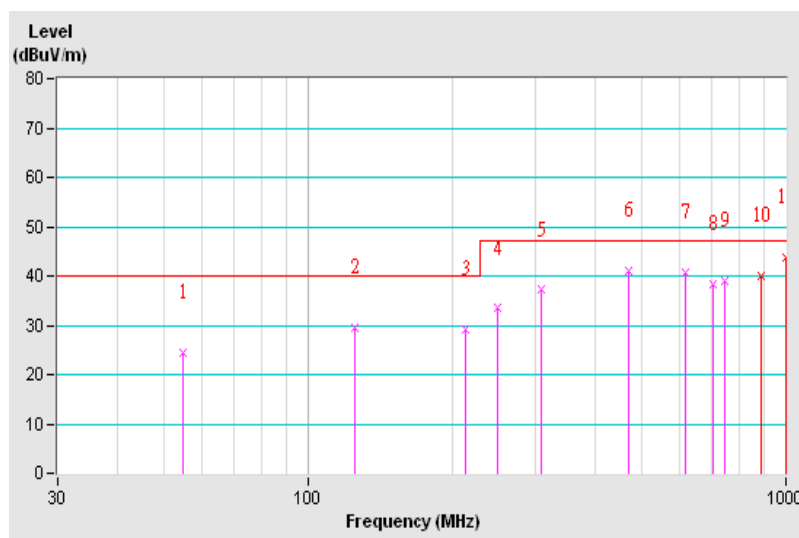

Frequency Range	30MHz ~ 1GHz	Detector Function & Resolution Bandwidth	Quasi-Peak (QP), 120kHz
Tested by	Vhenson Huang	Environmental Conditions	25°C, 63%RH
Test Mode	Mode 1		

Antenna Polarity & Test Distance : Vertical at 10 m

No	Frequency (MHz)	Emission Level (dBuV/m)	Limit (dBuV/m)	Margin (dB)	Antenna Height (m)	Table Angle (Degree)	Raw Value (dBuV)	Correction Factor (dB/m)
1	40.16	33.64 QP	40.00	-6.36	1.44 V	101	19.53	14.11
2	68.72	33.80 QP	40.00	-6.20	2.02 V	329	20.63	13.17
3	85.83	30.18 QP	40.00	-9.82	1.83 V	211	20.75	9.43
4	125.00	32.68 QP	40.00	-7.32	1.00 V	211	19.36	13.32
5	154.28	30.91 QP	40.00	-9.09	1.00 V	291	15.43	15.48
6	216.12	30.98 QP	40.00	-9.02	1.00 V	44	18.45	12.53
7	261.05	37.90 QP	47.00	-9.10	1.00 V	19	22.79	15.11
8	468.75	42.89 QP	47.00	-4.11	1.00 V	187	21.24	21.65
9	617.18	38.68 QP	47.00	-8.32	2.60 V	66	13.52	25.16
10	750.01	37.58 QP	47.00	-9.42	2.30 V	67	10.22	27.36
11	890.62	39.70 QP	47.00	-7.30	2.51 V	259	10.50	29.20
12	999.99	41.89 QP	47.00	-5.11	2.01 V	252	11.22	30.67

Remarks:

1. Emission Level(dBuV/m) = Raw Value(dBuV) + Correction Factor(dB/m)
2. Correction Factor(dB/m) = Antenna Factor (dB/m) + Cable Factor (dB) – Pre-Amplifier Factor (dB)
3. The other emission levels were very low against the limit.
4. Margin value = Emission level – Limit value

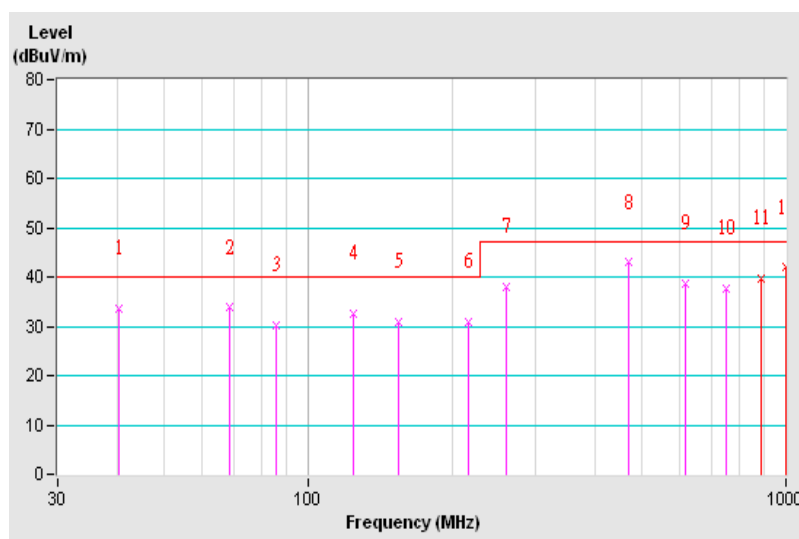

7 Radiated Emissions above 1 GHz

7.1 Limits

Emissions radiated outside of the specified bands, shall be according to the general radiated limits as following:

Radiated Emissions Limits at 10 meters (dB μ V/m)				
Frequencies (MHz)	FCC 15B / ICES-003, Class A	FCC 15B / ICES-003, Class B	CISPR 22, Class A	CISPR 22, Class B
1000-3000	Avg: 49.5	Avg: 43.5	Not defined	Not defined
Above 3000	Peak: 69.5	Peak: 63.5	Not defined	Not defined

Radiated Emissions Limits at 3 meters (dB μ V/m)				
Frequencies (MHz)	FCC 15B / ICES-003, Class A	FCC 15B / ICES-003, Class B	CISPR 22, Class A	CISPR 22, Class B
1000-3000	Avg: 60	Avg: 54	Avg: 56 Peak: 76	Avg: 50 Peak: 70
Above 3000	Peak: 80	Peak: 74	Avg: 60 Peak: 80	Avg: 54 Peak: 74

- Notes: 1. The lower limit shall apply at the transition frequencies.
 2. Emission level (dB μ V/m) = 20 log Emission level (uV/m).
 3. As shown in 15.35(b), for frequencies above 1000MHz, the field strength limits are based on average detector, however, the peak field strength of any emission shall not exceed the maximum permitted average limits, specified above by more than 20dB under any condition of modulation.

Frequency Range (For unintentional radiators)

Highest frequency generated or used in the device or on which the device operates or tunes (MHz)	Upper frequency of measurement range (MHz)
Below 1.705	30
1.705-108	1000
108-500	2000
500-1000	5000
Above 1000	5th harmonic of the highest frequency or 40GHz, whichever is lower



7.2 Test Instruments

Description & Manufacturer	Model No.	Serial No.	Cal. Date	Cal. Due
Agilent Spectrum	E4446A	MY51100009	May 30, 2015	May 29, 2016
Agilent Test Receiver	N9038A	MY50010135	Jul. 18, 2015	Jul. 17, 2016
Agilent Preamplifier	8449B	3008A02367	Feb. 27, 2015	Feb. 26, 2016
MITEQ Preamplifier	AMF-6F-260400-33-8P	892164	Mar. 01, 2015	Feb. 28, 2016
EMCI Preamplifier	EMC184045B	980235	Mar. 01, 2015	Feb. 28, 2016
Schwarzbeck Horn Antenna	BBHA-9170	212	Feb. 09, 2015	Feb. 08, 2016
EMCO Horn Antenna	3115	9312-4192	Feb. 09, 2015	Feb. 08, 2016
Max Full. Turn Table & Tower	MF7802	MF780208103	NA	NA
Software	Radiated_V8.7.07	NA	NA	NA
SUHNER RF cable With 4dB PAD	SF106-18	Cable-CH7	Aug. 15, 2015	Aug. 14, 2016
SUHNER RF cable With 3dB PAD	SF102	Cable-CH8-3.6m	Aug. 15, 2015	Aug. 14, 2016

- Notes:
1. The calibration interval of the above test instruments is 12 months and the calibrations are traceable to NML/ROC and NIST/USA.
 2. The test was performed in Chamber No. 7.
 3. The Industry Canada Reference No. IC 7450E-7.
 4. The FCC Site Registration No. 127748.
 5. The VCCI Site Registration No. G-39.
 6. Tested Date: Oct. 16, 2015.

7.3 Test Arrangement

- The EUT was placed on the top of a rotating table 0.8 meters above the ground at an accredited chamber room. The table was rotated 360 degrees to determine the position of the highest radiation.
- The EUT was set 3 meters away from the interference-receiving antenna, which was mounted on the top of a variable-height antenna tower.
- The height of antenna can be varied from one meter to four meters, the height of adjustment depends on the EUT height and the antenna 3dB beamwidth both, to detect the maximum value of the field strength. Both horizontal and vertical polarizations of the antenna are set to make the measurement.
- For each suspected emission, the EUT was arranged to its worst case and then the antenna was tuned to heights and the rotatable table was turned from 0 degrees to 360 degrees to find the maximum reading.
- The spectrum analyzer system was set to peak and average detect function and specified bandwidth with maximum hold mode when the test frequency is above 1 GHz.

Note: The resolution bandwidth of test receiver/spectrum analyzer is 1MHz and video bandwidth is 3MHz for Peak detection (PK) at frequency above 1GHz. The resolution bandwidth of test receiver/spectrum analyzer is 1 MHz for Average detection (AV) at frequency above 1GHz.

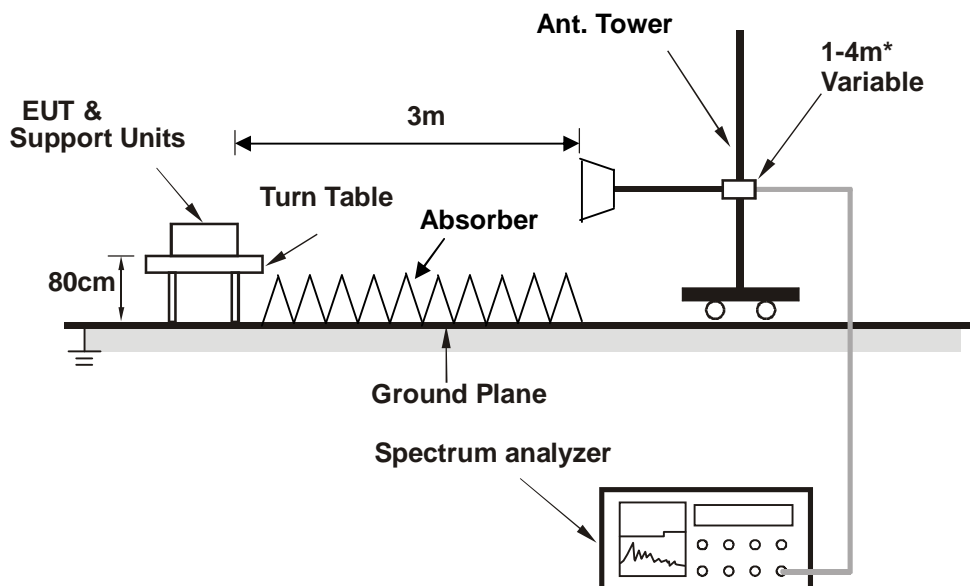

* :depends on the EUT height and the antenna 3dB beamwidth both.

For the actual test configuration, please refer to the related item – Photographs of the Test Configuration.

7.4 Test Results

Frequency Range	1GHz ~ 11GHz	Detector Function & Resolution Bandwidth	Peak (PK) / Average (AV), 1MHz
Tested by	Kobe Lu	Environmental Conditions	22°C, 78%RH
Test Mode	Mode 1		

Antenna Polarity & Test Distance : Horizontal at 3 m								
No	Frequency (MHz)	Emission Level (dBuV/m)	Limit (dBuV/m)	Margin (dB)	Antenna Height (m)	Table Angle (Degree)	Raw Value (dBuV)	Correction Factor (dB/m)
1	1302.82	53.34 PK	80.00	-26.66	1.40 H	140	56.14	-2.80
2	1302.82	33.42 AV	60.00	-26.58	1.40 H	140	36.22	-2.80
3	1538.75	53.42 PK	80.00	-26.58	1.11 H	210	55.04	-1.62
4	1538.75	43.21 AV	60.00	-16.79	1.11 H	210	44.83	-1.62
5	2962.02	55.13 PK	80.00	-24.87	1.25 H	259	52.23	2.90
6	2962.02	36.97 AV	60.00	-23.03	1.25 H	259	34.07	2.90

Remarks:

1. Emission Level(dBuV/m) = Raw Value(dBuV) + Correction Factor(dB/m)
2. Correction Factor(dB/m) = Antenna Factor (dB/m) + Cable Factor (dB) – Pre-Amplifier Factor (dB)
3. The other emission levels were very low against the limit.
4. Margin value = Emission level – Limit value

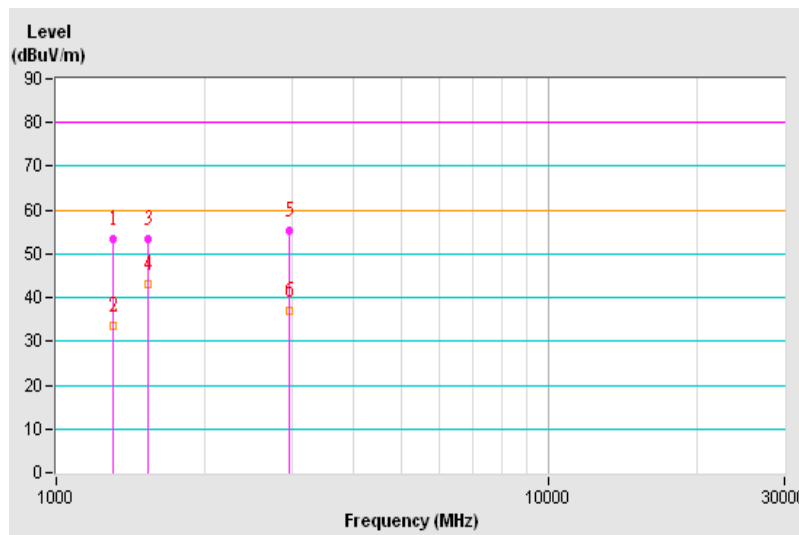

Frequency Range	1GHz ~ 11GHz	Detector Function & Resolution Bandwidth	Peak (PK) / Average (AV), 1MHz
Tested by	Kobe Lu	Environmental Conditions	22°C, 78%RH
Test Mode	Mode 1		

Antenna Polarity & Test Distance : Vertical at 3 m								
No	Frequency (MHz)	Emission Level (dBuV/m)	Limit (dBuV/m)	Margin (dB)	Antenna Height (m)	Table Angle (Degree)	Raw Value (dBuV)	Correction Factor (dB/m)
1	1317.09	57.04 PK	80.00	-22.96	1.75 V	125	59.75	-2.71
2	1317.09	33.80 AV	60.00	-26.20	1.75 V	125	36.51	-2.71
3	1743.62	54.61 PK	80.00	-25.39	1.00 V	128	55.39	-0.78
4	1743.62	33.53 AV	60.00	-26.47	1.00 V	128	34.31	-0.78
5	2962.10	55.11 PK	80.00	-24.89	1.00 V	197	52.21	2.90
6	2962.10	37.57 AV	60.00	-22.43	1.00 V	197	34.67	2.90

Remarks:

1. Emission Level(dBuV/m) = Raw Value(dBuV) + Correction Factor(dB/m)
2. Correction Factor(dB/m) = Antenna Factor (dB/m) + Cable Factor (dB) – Pre-Amplifier Factor (dB)
3. The other emission levels were very low against the limit.
4. Margin value = Emission level – Limit value

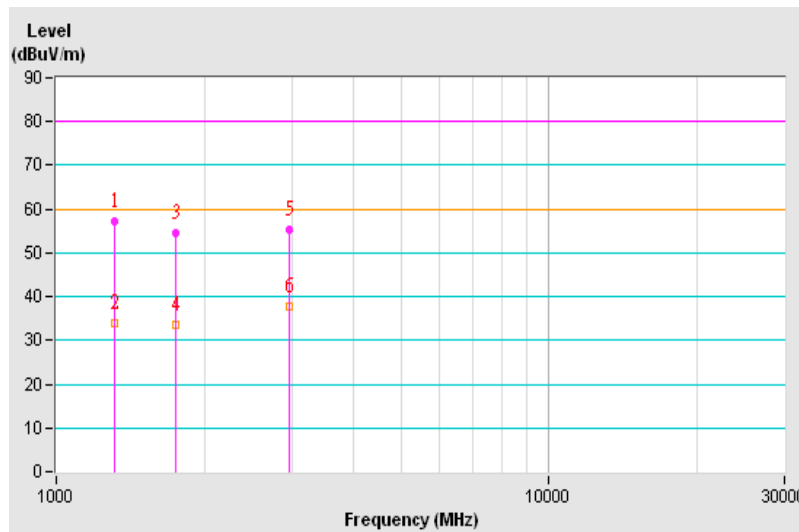

8 Pictures of Test Arrangements

8.1 Conducted Emissions at Mains Ports

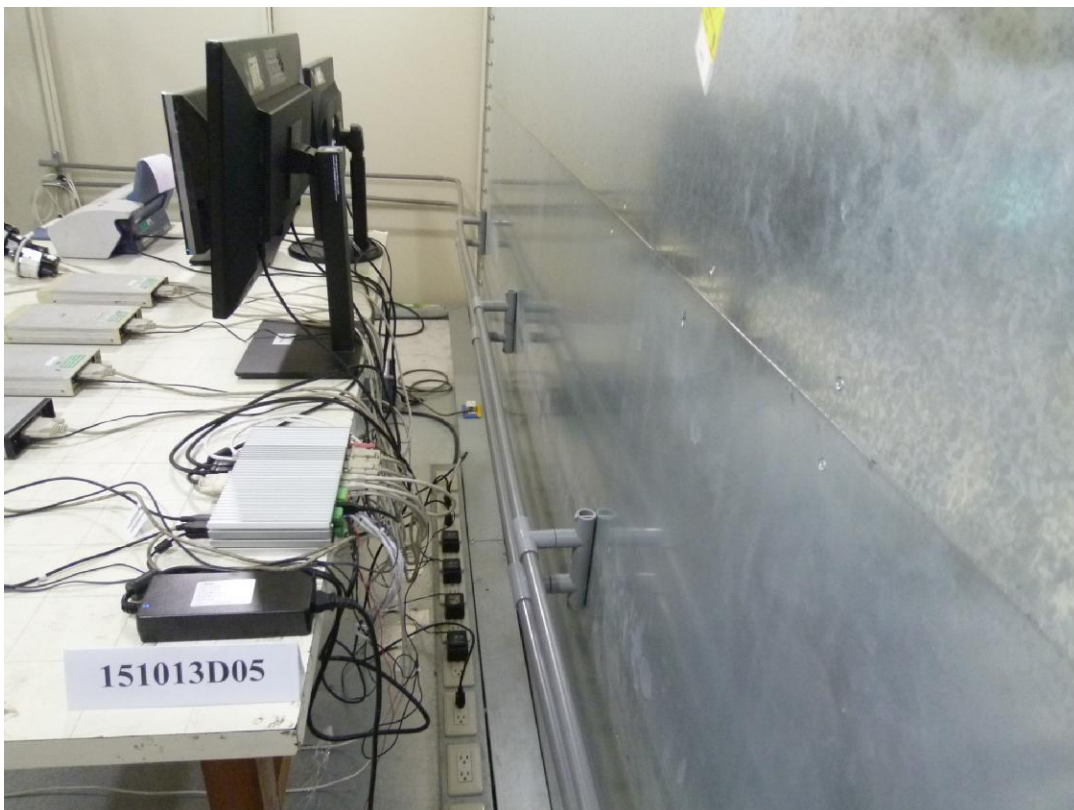
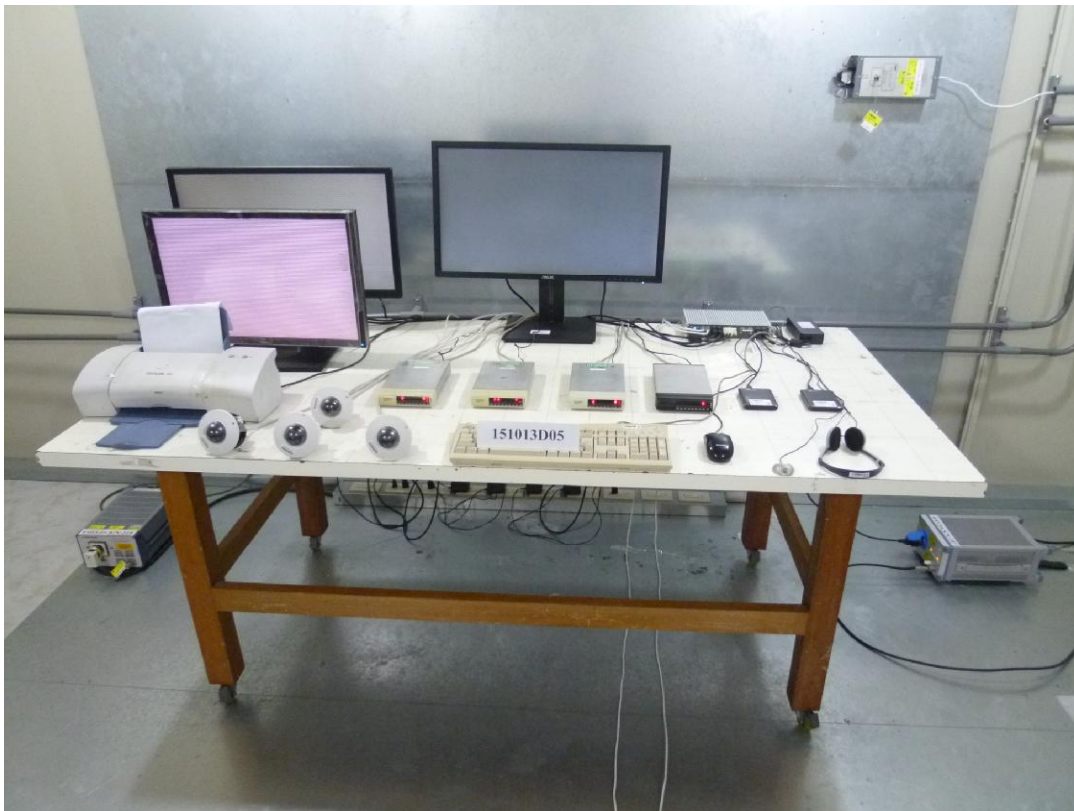

8.2 Radiated Emissions up to 1 GHz



8.3 Radiated Emissions above 1 GHz



Appendix – Information on the Testing Laboratories

We, Bureau Veritas Consumer Products Services (H.K.) Ltd., Taoyuan Branch, were founded in 1988 to provide our best service in EMC, Radio, Telecom and Safety consultation. Our laboratories are accredited and approved according to ISO/IEC 17025.

If you have any comments, please feel free to contact us at the following:

Linko EMC/RF Lab

Tel: 886-2-26052180

Fax: 886-2-26051924

Hsin Chu EMC/RF/Telecom Lab

Tel: 886-3-6668565

Fax: 886-3-6668323

Hwa Ya EMC/RF/Safety Lab

Tel: 886-3-3183232

Fax: 886-3-3270892

Email: service.adt@tw.bureauveritas.com

Web Site: www.bureauveritas-adt.com

The address and road map of all our labs can be found in our web site also.

--- END ---